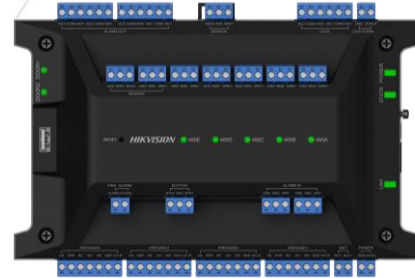

**DS-K2702X(P)  
Access Controller**

The access controller supports web configuration, which is no need to install software on a PC. By connecting with access modules via RS-485, it can extend to control up to 126 doors, which is suitable for the scenarios of subways, airports, banks, large groups and other industry projects.

- Supports 2 door control. It can extend up to 62 DS-K2M002X access modules, and up to 126 doors can be controlled
- Downstream RS-485 redundancy wiring design to ensure communication stability. 5-ch downlink RS-485 interface supports two applications: 1. When 4-ch RS-485 communication, the 5th RS-485 can be used as a redundant application; 2. 4-ch RS-485 forms 2 groups of dual-bus loops with physical isolation. It is recommended that you do not have more than 16 access modules attached to each loop bus.
- Web configuration management. All configurations can be realized via web without software application
- Supports professional access control applications such as multi-door interlocking and anti-passback
- Supports backup battery access. Charging and discharging are available
- It has status indicators such as power supply, communication and operation, which is convenient for equipment health detection

## ▪ Specification

System	
Operating system	Linux
Network	
Wired network	1, 10/100/1000 Mbps self-adaptive
Interface	
Network interface	1
Lock control	2
Exit button	2
Door contact input	2
Alarm input	4
Alarm output	4
TAMPER	1
RS-485	7, 2 for card reader, 5 for access modules (4 for communication, each interface can connect up to 16 access modules; 1 for redundancy)
Wiegand	4, standard 26/34 input, supports custom Wiegand settings
USB	1, USB 2.0
Fire interface	1
Capacity	
User capacity	100,000
Fingerprint capacity	10,000
Card capacity	200,000
Event capacity	600,000
Linked door capacity	Self: 2 doors Extended: up to 126 doors (connected with 62 access modules)
Linked card reader capacity	4 RS-485 card readers (OSDP protocol) and 4 Wiegand card readers
Authentication	
Fingerprint recognition duration	< 1 s
General	
Indicator	10 indicators, 1 for indicating power status, 1 for running status, 1 for wired network status, 5 for RS-485 status, and 2 for door status
Battery	Charge and discharge
Power supply	12 ± 15% VDC
Power consumption	≤ 72 W
Working temperature	-10 °C to 55 °C (14 °F to 131 °F)
Working humidity	0% to 90% (No condensing)
Installation	Installation with guide rail
Language	English, Thai, Traditional Chinese, Indonesian, Vietnamese, Arabic, Spanish (Europe), Spanish (South America), Italian, French, Dutch, Russian, Ukrainian, Portuguese (Europe), Portuguese (Brazil), Serbian, Croatian, Bulgarian, German, Greek, Romanian
Function	
Configuration via Web browser	Support
Multi-factor authentication	Support
First person in	Support

Anti-passback	Support 32 routes (64 card readers each)
Multi-door interlocking	Support 32 groups (32 doors each)

▪ **Typical Application**

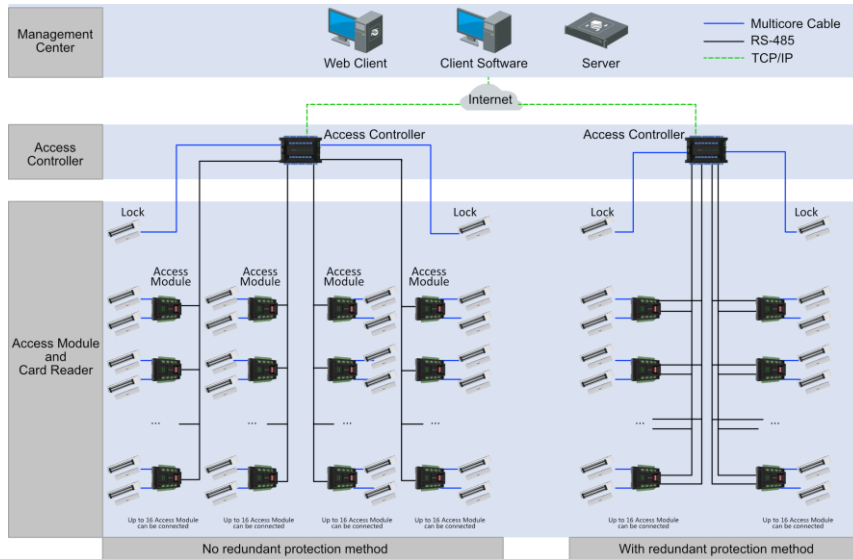

▪ **Available Model**

DS-K2702X(P)

▪ **Dimension**

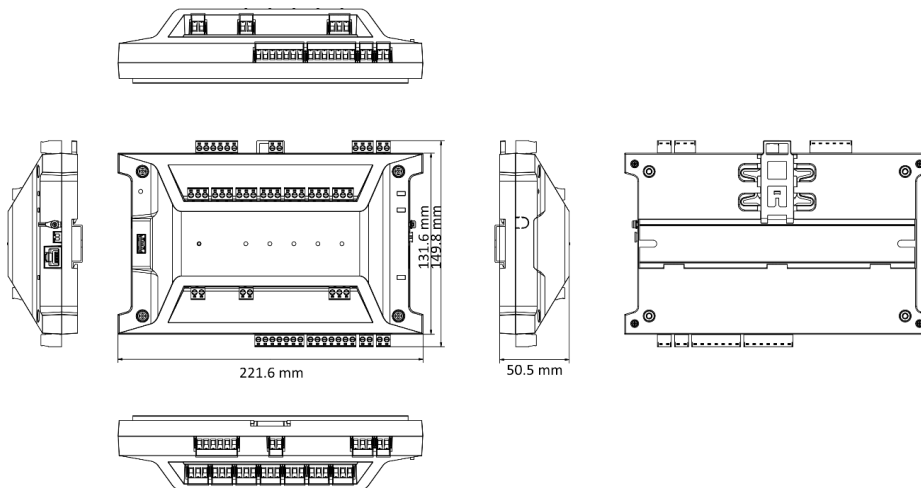

▪ **Accessory**

▪ **Optional**

